

EBRI-Milken Institute
Retirement
Symposium: The
Forces Transforming
Retirement

EBRI EMPLOYEE BENEFIT
RESEARCH INSTITUTE

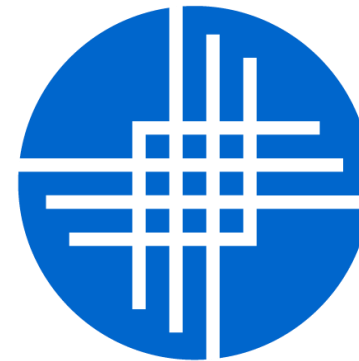

**MILKEN
INSTITUTE**

Thank you to our Sponsors!



Keynote Opening Speaker – Humanizing Retirement: Behavioral Finance 2.0, AI, and the Future of Engagement

Brian Portnoy, Author of *The Geometry of Wealth* and *How I Invest My Money*, and Founder, Shaping Wealth

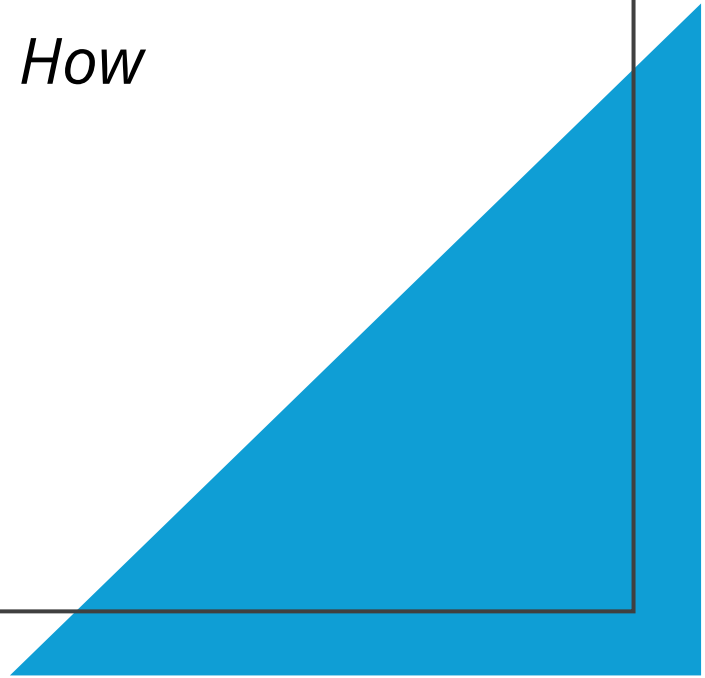

Innovations and FinTech Developments that Help Savers Help Themselves

- Sunil Gangwani, Co-Founder and CEO, Plootus
- Ana Mahony, Founder and CEO, Addition Wealth
- Cash Lafferty, Founder and CEO, PandoAlts
- Dan Beck, CEO and Co-Founder, 401Go
- *Moderator:* Yaqub "Qub" Ahmed, Global Head of Retirement, Workplace and Wealth, Franklin Templeton

Networking Break

Thank you to our Sponsors!

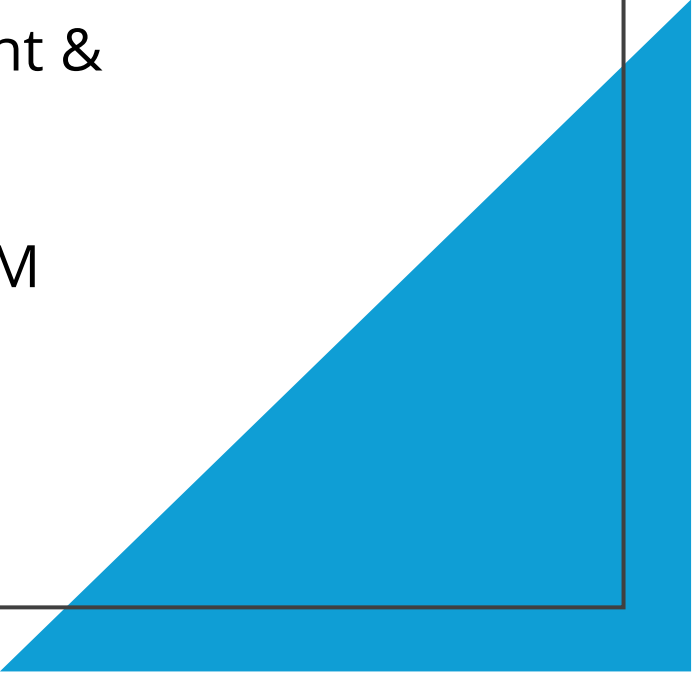

Plan Sponsor View – Supporting Employee Decision Making Across Demographics

- Justin Roberts, Sr. Manager, Financial Benefits, Amazon
 - Laura Schumann, Vice President, Product Development & Management, National Rural Electric Cooperative Association
 - Alexander Alonso, Chief Data & Analytics Officer, SHRM
 - *Moderator:* Barb Marder, President and CEO, EBRI
- 

EBRI Research Presentation & Table Dialogue — At/After Retirement Decisions

- Craig Copeland, Director, Wealth Benefits Research, EBRI

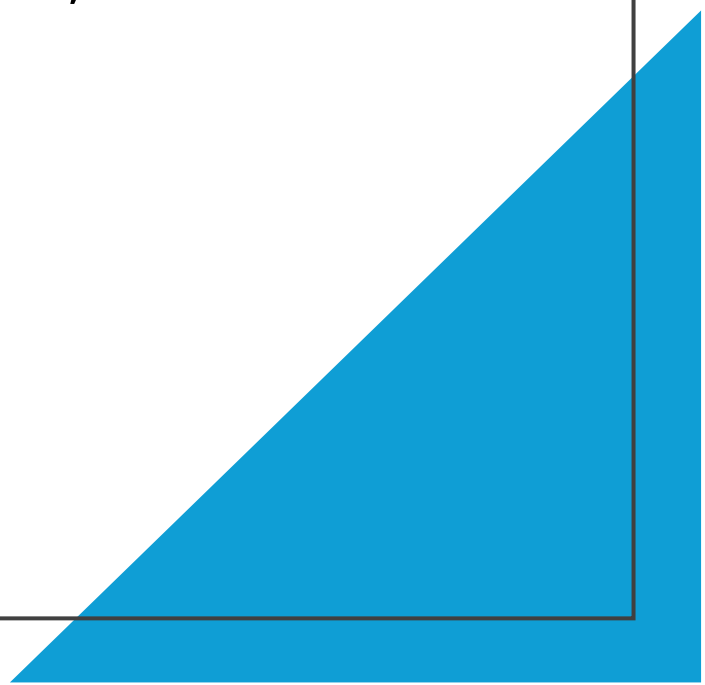



The Impact of the RMD Rules on IRA Distributions: An Examination of the Rule Changes from 2019-2021

Craig Copeland, EBRI

Presentation Overview

- Background on required minimum distributions (RMDs) and IRA data
- Incidence of distributions during years with RMD rule changes
 - 2019 and 2021 by age
 - 2019-2021 by age
 - Account balance
 - Gender
- Longitudinal results
 - Percentage of those taking distributions in 2019 who did or did not take them in 2020
 - Age and account balance
- Distribution Amounts
 - Average distribution rates
 - Percentage with distributions more than the RMD
- Roth Distributions

Background on RMD Rules

- 2019-A traditional IRA owner who turned 70 ½ years of age had to start taking distributions, but had until April 1, 2020, to take that distribution. Each subsequent year, the distribution must be made by December 31.
- 2020-The age was increased to 72, but the distribution requirement was suspended under COVID legislation.
- 2021-The first year of age 72 being fully in effect, but individuals still had until April 1, 2022, for the first distribution. All other ages above 72 had to make the distribution by December 31, 2021.
- The distribution amount is calculated by dividing the December 31 balance of the prior year by the life expectancy factors published by the Internal Revenue Service (IRS). For example, in 2019, the life expectancy factor was 27.4 for those age 70, so for every \$1,000, the individual must have withdrawn \$36.50.
- If an individual owns more than one IRA, the amount required to be taken out of the IRAs must be calculated for each traditional IRA owned. However, the total required distribution can be taken out of only one of them.
- In 2022, the life expectancy factors were increased, so the required amount to be distributed decreased for each age. In 2023, the RMD age increased to 73, and in 2033, the age will go to 75.

Data: EBRI IRA Database

- Focus of the study is over 3 million IRAs that are maintained from 2019-2021 with at least \$10,000 at the end of year 2019.
- IRA type (e.g., Traditional, Rollover, or Roth)
- End of year balance
- Total distributions during the year
- Age and gender of the account owner

INCIDENCE OF DISTRIBUTIONS

Percentage of Individual Retirement Account Owners Who Took a Distribution in 2019, by Age of the Owner

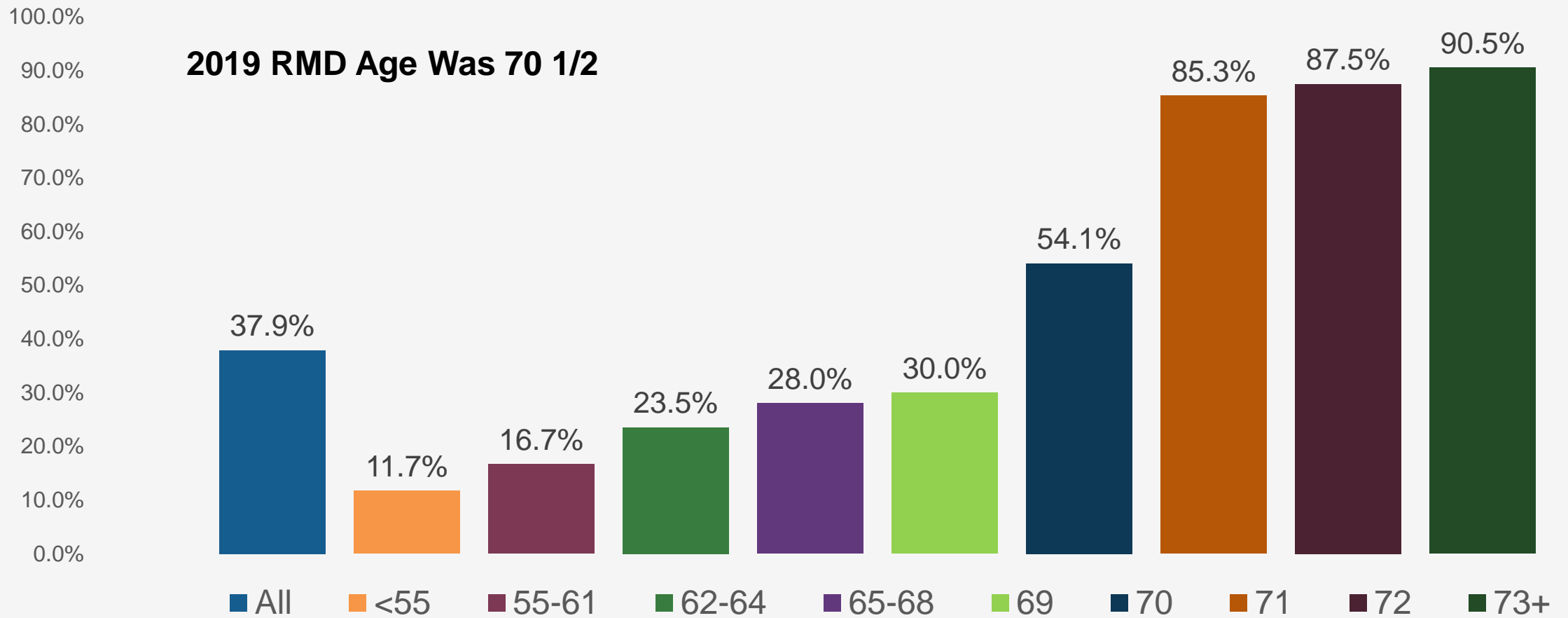

Source: EBRI IRA Database.

Percentage of Individual Retirement Account (IRA) Owners Who Took a Distribution in 2019 and 2021, by Age of the Owner

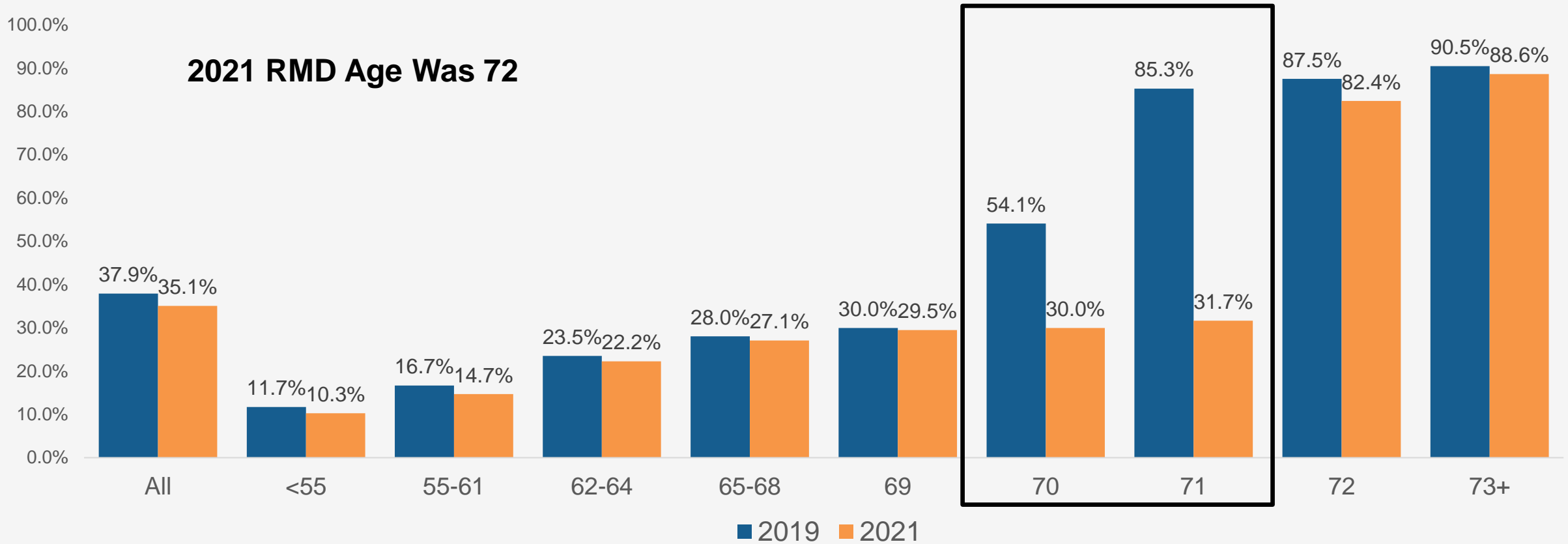

Note: Traditional and Rollover IRA Owners with a minimum balance of \$10,000 at the end of the respective year.
 Source: EBRI IRA Database.

Percentage of Individual Retirement Account (IRA) Owners Who Took a Distribution in 2019, 2020, and 2021, by Age of the Owner

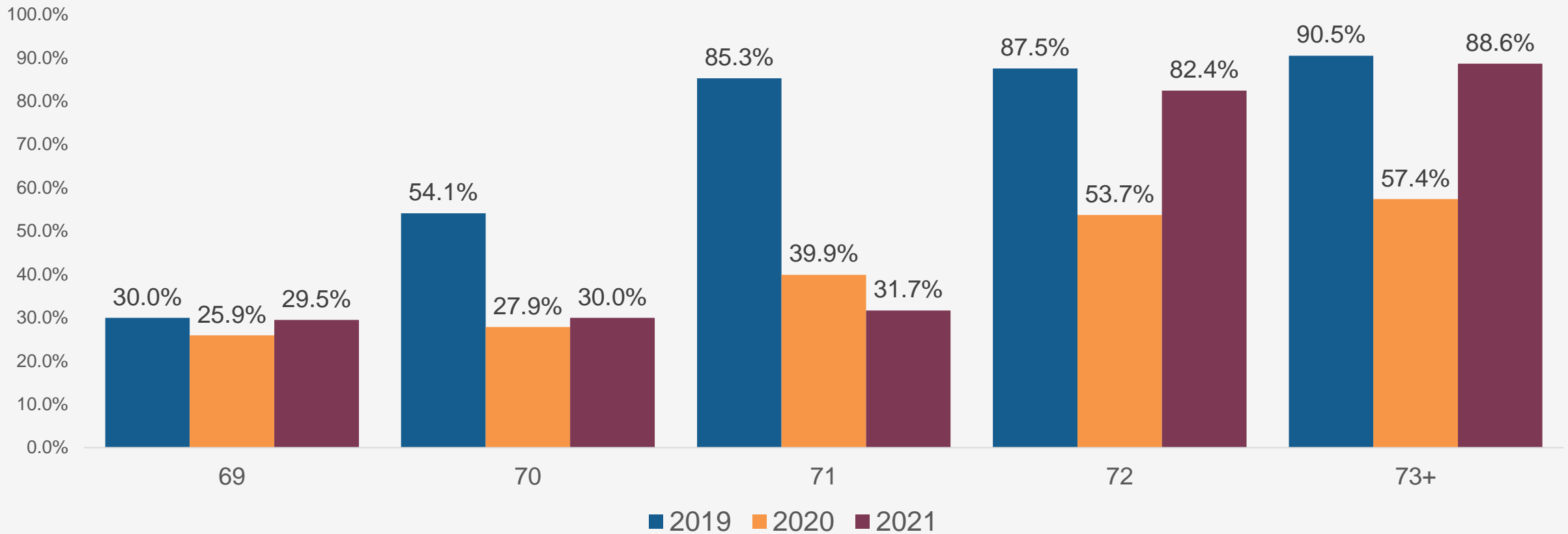

Note: Traditional and Rollover IRA Owners with a minimum balance of \$10,000 at the end of the respective year.
Source: EBRI IRA Database.

Percentage of Individual Retirement Account (IRA) Owners Who Took a Distribution in 2019, 2020, and 2021, by Age of the Owner and Account Balance

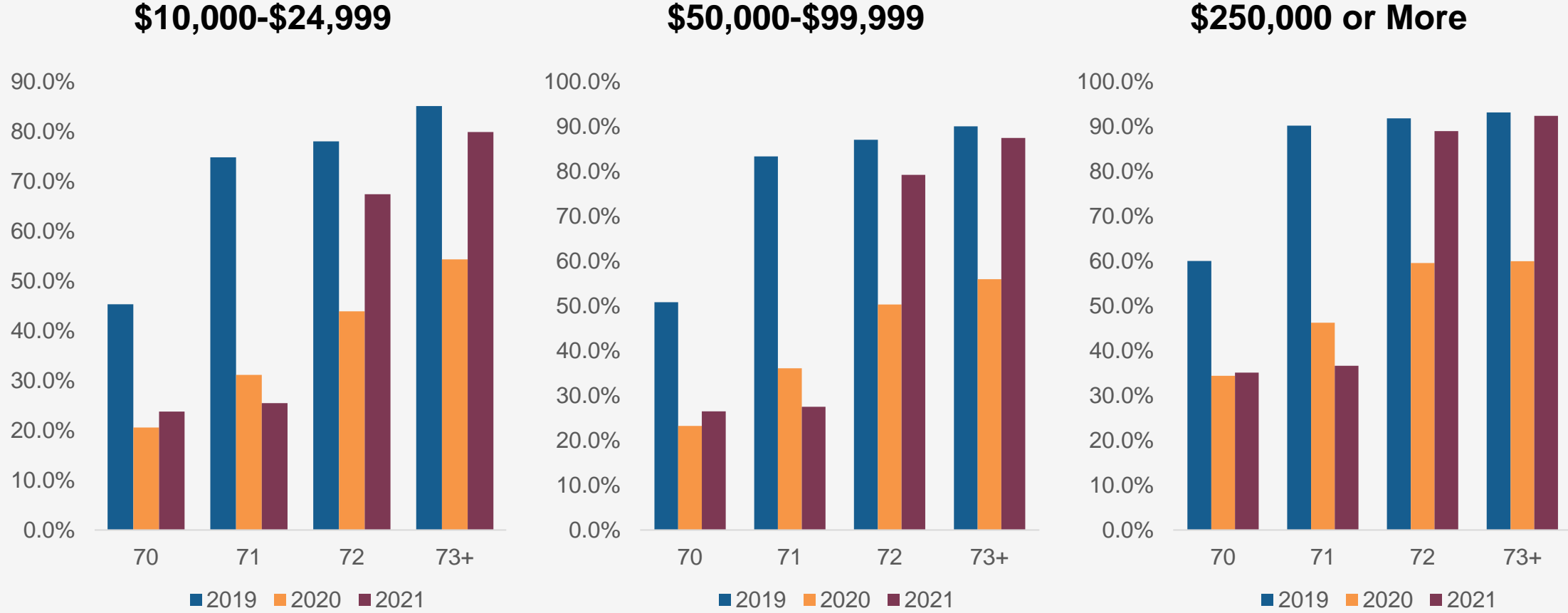

Note: Traditional and Rollover IRA Owners with a minimum balance of \$10,000 at the end of the respective year.
 Source: EBRI IRA Database.

Percentage of Individual Retirement Account (IRA) Owners Who Took a Distribution in 2019, 2020, and 2021, by Age of the Owner and Gender

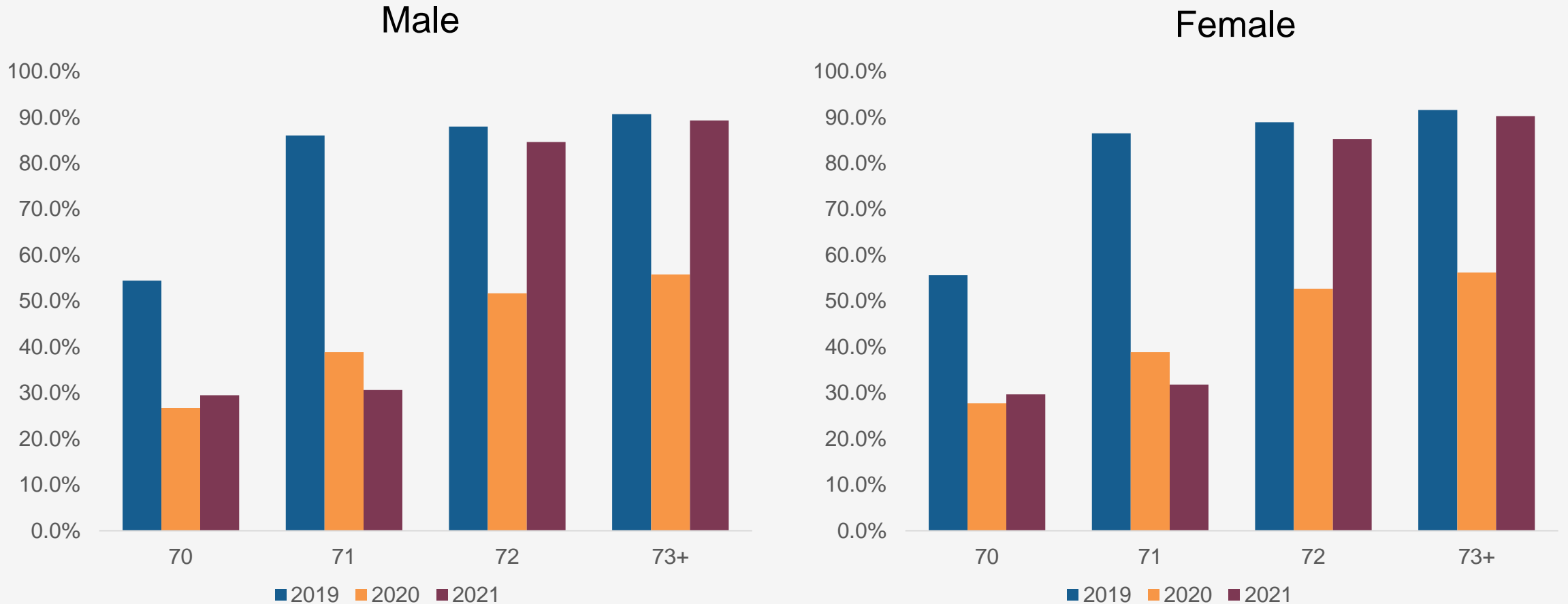

Note: Traditional and Rollover IRA Owners with a minimum balance of \$10,000 at the end of the respective year.

Source: EBRI IRA Database.

LONGITUDINAL RESULTS

Percentage of Those Who Took a Distribution in 2019 Who Continued Taking Them in 2020 and 2021 and Those Who Stopped in 2020 and Continued in 2021, by Age of IRA Owner

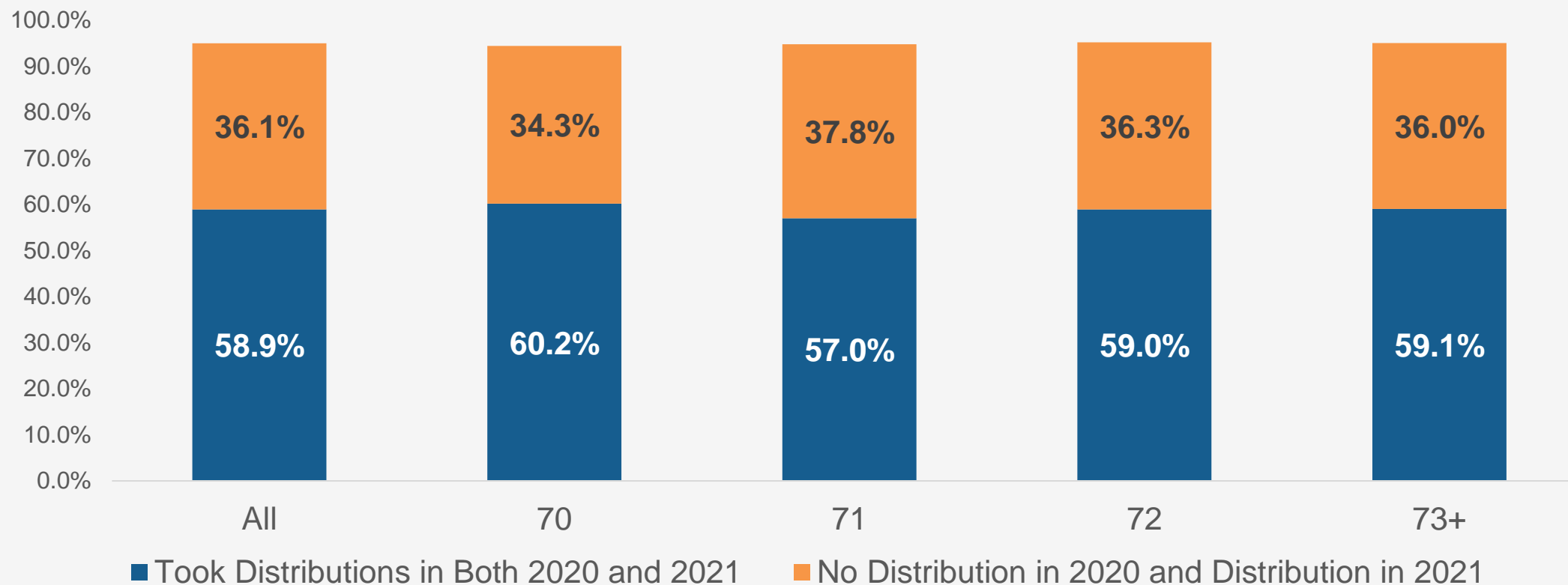

Note: Traditional and Rollover IRA Owners with a minimum balance of \$10,000 at the end of 2019.
Age is from 2019.

Source: EBRI IRA Database.

Percentage of Those Who Took a Distribution in 2019 Who Continued Taking Them in 2020 and 2021 and Those Who Stopped in 2020 and Continued in 2021, by Account Balance

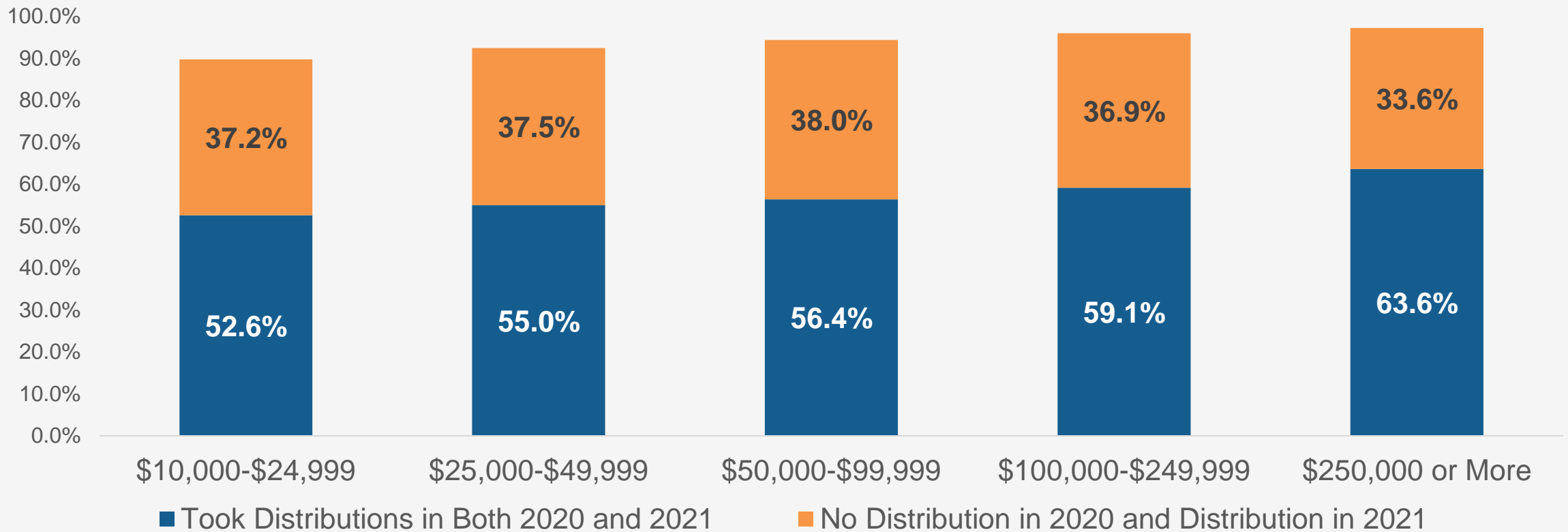

Note: Traditional and Rollover IRA Owners with a minimum balance of \$10,000 at the end of 2019. The account balance is the end of year 2019 balance.

Source: EBRI IRA Database.

DISTRIBUTION AMOUNTS

Average Distribution Rate of Individual Retirement Account (IRA) Owners Who Took a Distribution in 2019 and 2021, by Age of the Owner

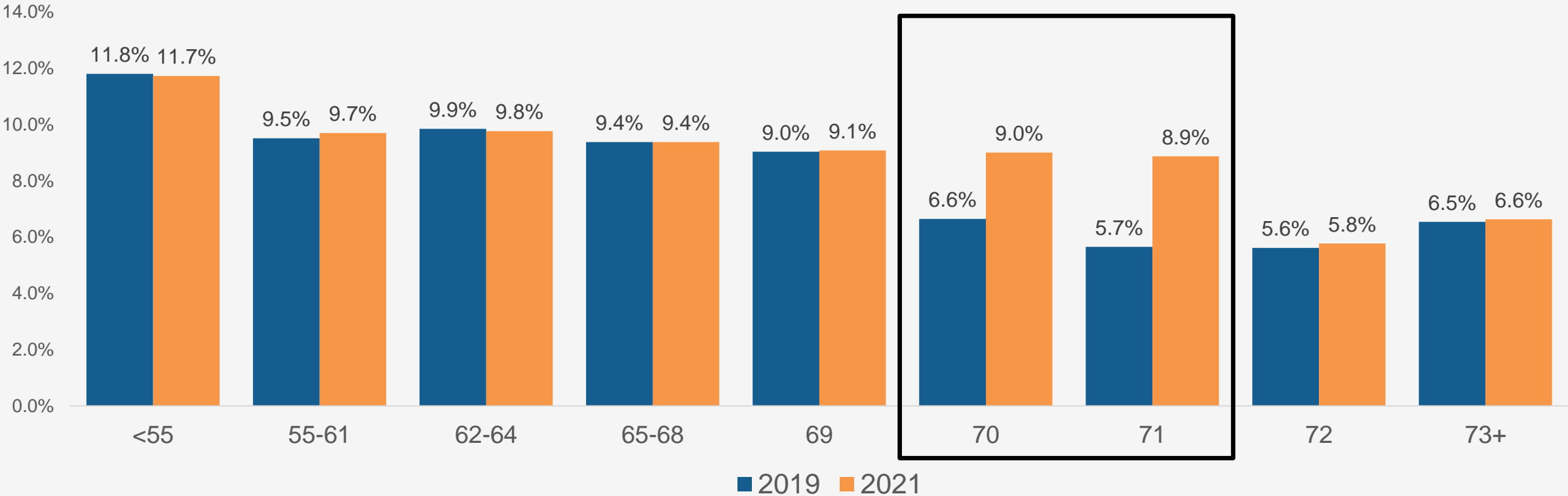

Distribution rate=distribution amount/(distribution amount + account balance).

Note: Traditional and Rollover IRA Owners with a minimum balance of \$10,000 at the end of the respective year.

Source: EBRI IRA Database.

Percentage of Distributions Larger Than the Required Amount for Those Ages 70 or Older Who Took a Distribution in 2019, by Age, 2020-2021

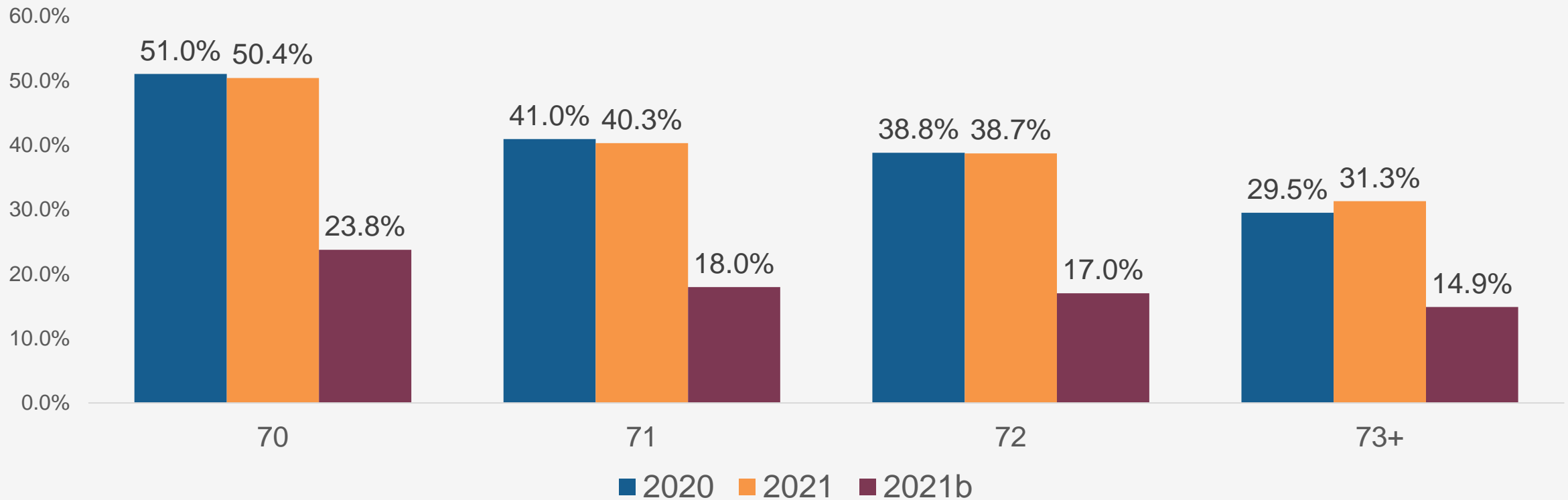

Note: 2021-The percentage in 2021 among those who also took a distribution in 2020.

2021b-The percentage in 2021 among those who did *not* take a distribution in 2020.

Traditional and Rollover IRA Owners with a minimum balance of \$10,000 at the end of 2019 who took a distribution in 2019.

Source: EBRI IRA Database.

ROTH DISTRIBUTIONS

Percentage of Roth IRA Owners Who Took a Distribution in 2019-2021, by Age of the Owner

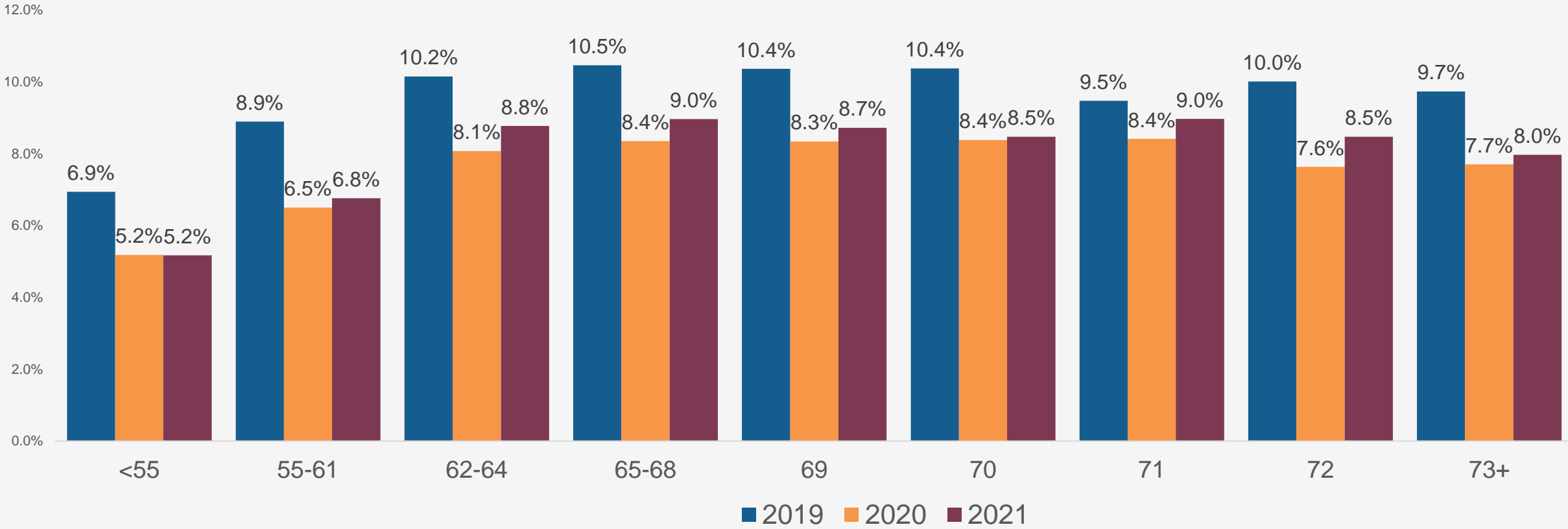

Note: Roth IRA Owners with a minimum balance of \$10,000 at the end of the respective year.
 Source: EBRI IRA Database.

Takeaways

- The RMD rules are the default withdrawal strategy for many who have IRAs.
- These rules have a major impact on when IRA owners take a distribution and the amount of the distribution.
- The distribution rate is smaller among those who are taking required distributions than for those who are taking distributions before they are required.
- Account balance and gender appear to not have a large impact on the distribution decisions.
- Roth distributions were age indifferent at ages 62 or older and not impacted by the 2020 suspension of RMDs.

Table Discussion Questions

1. Did you expect the required minimum distribution (RMD) rule changes to have a significant impact?
2. Do plans have a role to play in the distribution/withdrawal strategies of participants?
3. What should that role be?
4. What products or strategies should be employed for potentially better methods of changing assets and into income?

Lunch!

Thank you to our Sponsors!



Milken Research Presentation & Table Dialogue: Next Steps in Moving Forward with In-Plan Lifetime Income

- Cheryl Evans, Director, Lifetime Financial Security, MI Finance, Milken Institute

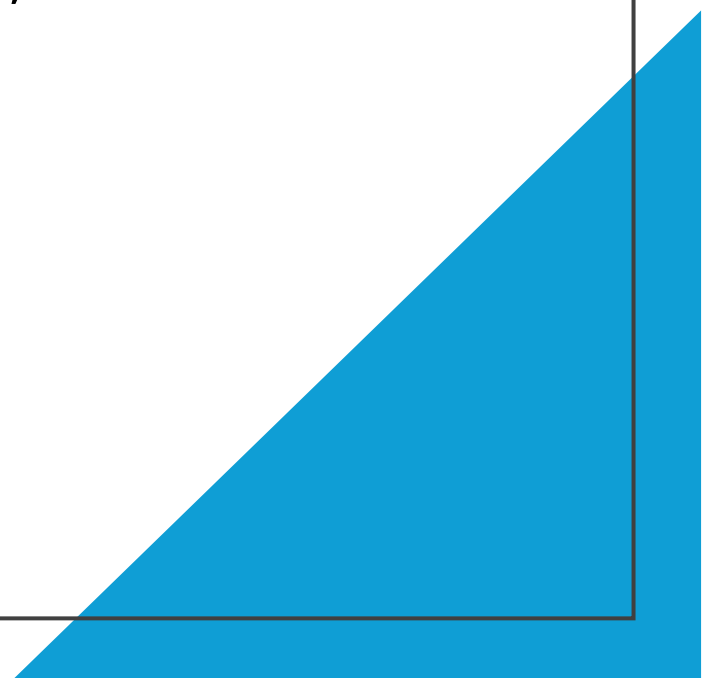



Enhancing Retirement Security: Advancing Lifetime Income for All

Questions for Consideration:

- 1. Asset Class Definition** – What could be done collectively, as an industry, to help create the guaranteed retirement income asset class?
- 2. Safe Harbor** – Do you agree that more clarity on the existing safe harbors will make a difference in plan sponsor adoption?
- 3. Education** – What are some non-traditional ideas beyond marketing campaigns that would be useful in educating advisors/consultants, plan sponsors, and participants on guaranteed retirement income solutions?



- Cheryl Evans: cevans@milkeninstitute.org
 - 646-988-9972

Advancing AI in Retirement Update

- Sri Krishnamurthy, CEO & Founder, QuantUniversity
- Randy Blaha, Vice President, Retirement Solutions Technology, Nationwide
- Moderator: Bridget Bearden, Research and Development Strategist, EBRI

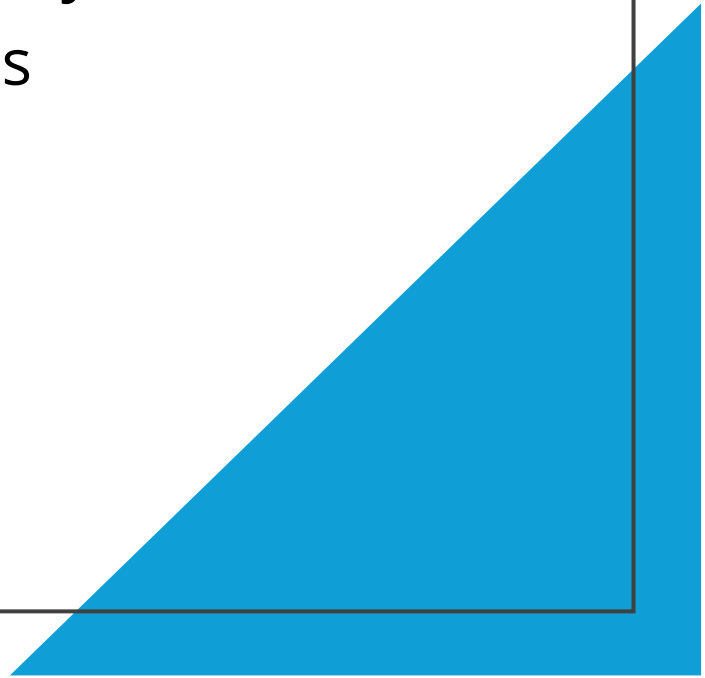



QuantUniversity, LLC

www.quantuniversity.com

AI and Large Language Models: Update for 2025

Presented By:

Sri Krishnamurthy, CFA, CAP

sri@quantuniversity.com

03/11/2025

EBRI-Milken Institute 2025 Retirement Symposium

Washington D.C.

AI QUIZ TIME!



How can I use AI?

If an AI system can process one pdf document in one minute, how many documents can it process in an hour?

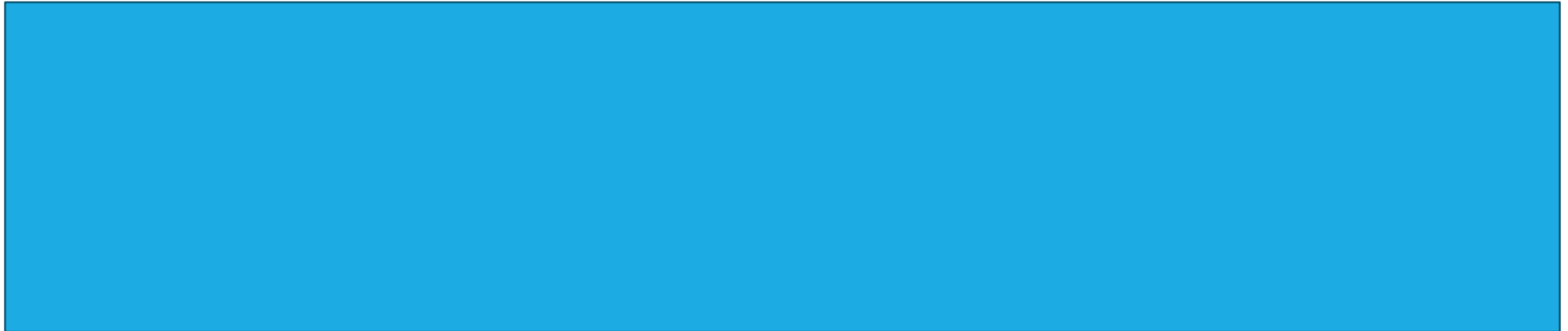

How can I use AI?

If an AI system can process one pdf document in one minute, how many documents can it process in an hour?

If an AI system can process one PDF document in one minute, then in one hour (which is 60 minutes), it can process:

$$1 \text{ document per minute} \times 60 \text{ minutes} = 60 \text{ documents}$$

So, the AI system can process 60 documents in one hour.

What if we use AI – Reasoning mode?

If an AI system can process one pdf document in one minute, how many documents can it process in an hour?
Research on capabilities of state-of-the-art AI systems and then answer after thinking!

< 5/5 >

Reasoned about AI document processing capabilities for 9 seconds ▾

Let's break this down carefully, using both the straightforward math **and** some context about how modern AI systems might behave in the real world:

1. The Straightforward Math

- If the system processes exactly **one PDF in one minute** in a purely **sequential** manner, then:

$$1 \text{ document per minute} \times 60 \text{ minutes per hour} = 60 \text{ documents per hour}$$

So, mathematically, you get 60 PDFs in an hour.



What if we use AI – Reasoning mode?

2. Real-World Considerations

1. Parallel Processing

Modern AI systems often run on hardware (e.g., GPUs or clusters of CPUs/GPUs) that can process multiple documents at once. If the system can scale horizontally (adding more machines or more GPU capacity), you could, in theory, process many documents simultaneously—well beyond 60 per hour.

2. Variability in Document Complexity

The term “process one PDF” can hide a lot of details:

- Some PDFs are short text documents.
- Others could be large, image-heavy, or require more complex OCR (optical character recognition).
- The time to process each PDF can vary widely in practice.

3. Overhead and Workflow Factors

- **Startup/Loading overhead:** The system might need extra time to initialize models, load PDF files, or handle concurrency.
- **Data Transfer:** If documents are large or stored remotely, network throughput might become a bottleneck.
- **Model Limits:** Some advanced language models (like large GPT-style models) can be fast once loaded, but loading or switching models might slow things down.

3. Putting It All Together

- **Idealized (Single Thread):** The simple arithmetic yields **60 PDFs per hour** if the AI can only process them one at a time.
- **State-of-the-Art, Parallel or Scalable Systems:** In practice, many systems distribute the workload across multiple servers or GPU workers, so effective throughput can be **significantly higher** than 60 per hour. 



So what's happened in the last year?

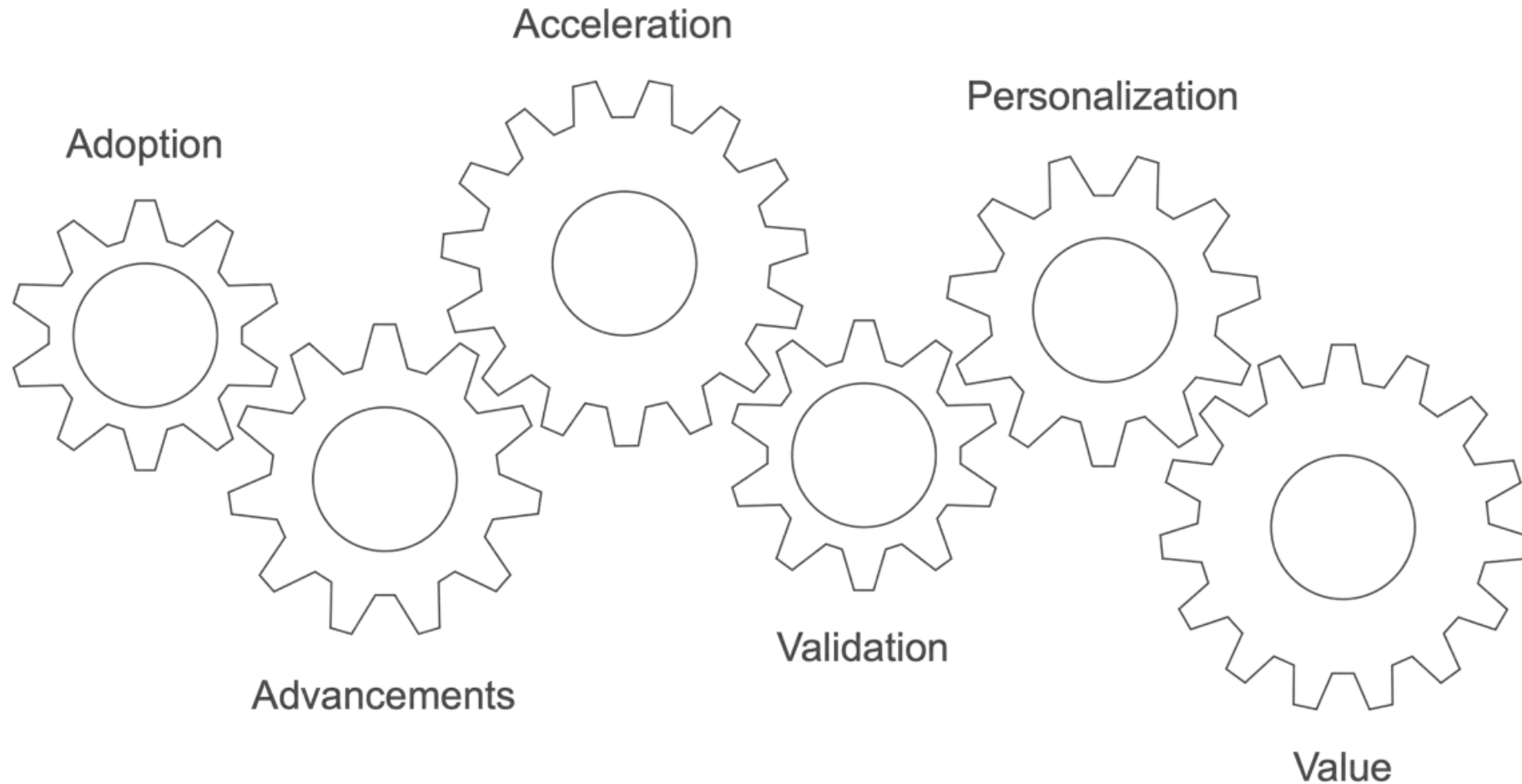

AI Adoption: Explicit and Implicit Roles

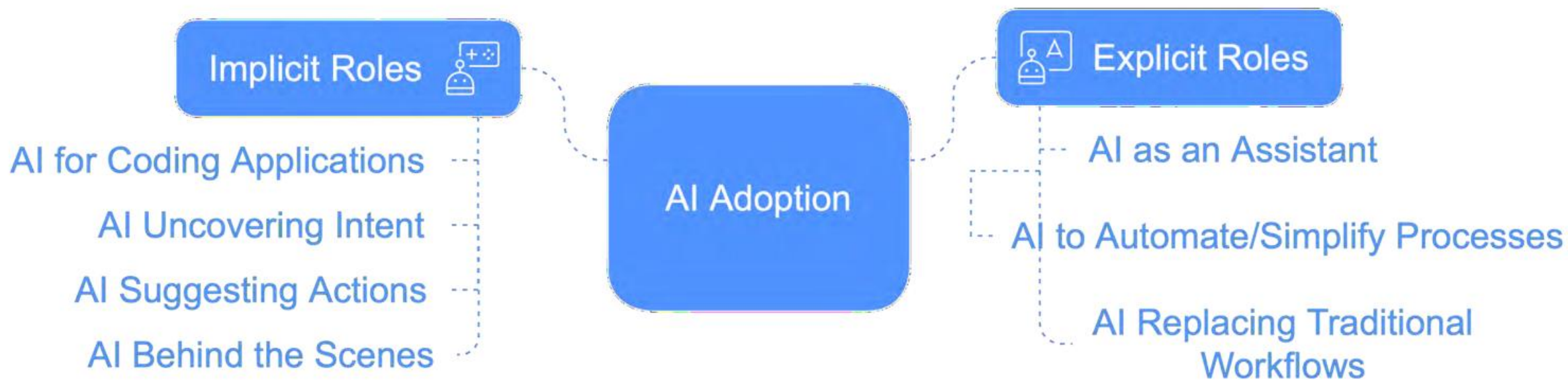

Advancements - Models

Model ⓘ

GPT-4o
Great for most questions

GPT-4o with scheduled tasks BETA
Ask ChatGPT to follow up later

GPT-4.5 RESEARCH PREVIEW
Good for writing and exploring ideas

o1 ✔
Uses advanced reasoning

o3-mini
Fast at advanced reasoning

o3-mini-high
Great at coding and logic

More models ➤

🔄 Temporary chat

GPT-4o mini
Faster for most questions

GPT-4
Legacy model



Advancements - Agents

Do multiple
steps

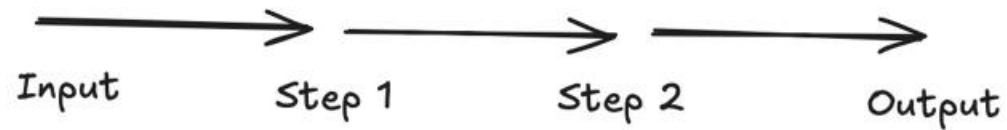

Reason,
Plan,
Leverage
Agents

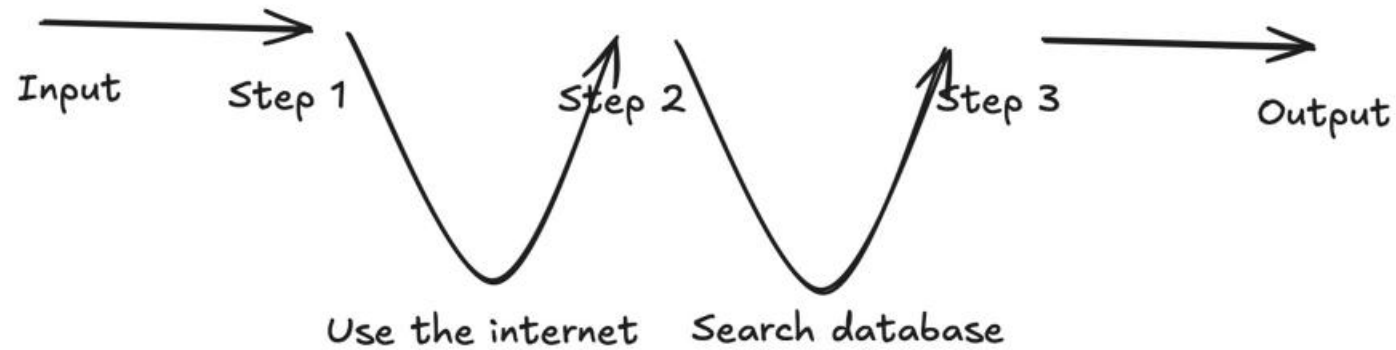

manus Comprehensive Tesla Stock Analysis and Investment Insights [Log in](#)

I'd like a thorough analysis of Tesla stock, including:

Summary: Company overview, key metrics, performance data and investment recommendations

Financial Data: Revenue trends, profit margins, balance sheet and cash flow analysis

Market Sentiment: Analyst ratings, sentiment indicators and news impact

Technical Analysis: Price trends, technical indicators and support/resistance levels

Compare Assets: Market share and financial metrics vs. key competitors

Value Investor: Intrinsic value, growth potential and risk factors

Investment Thesis: SWOT analysis and recommendations for different investor types

Manus

I'll help you create a comprehensive analysis of Tesla stock. I'll gather the latest financial data, market sentiment, technical analysis, competitive comparisons, and develop investment recommendations. This will take some time to research thoroughly, but I'll work on it right away and provide you with a detailed report.

- Connected to datasource(s)
 - Get stock chart
 - Get stock holders
 - Get stock insights
 - Get stock profile
 - Get stock SEC filing
 - Get what analysts are saying of a stock

Create comprehensive Tesla stock analysis task list

```

Manus's Computer
Manus is using Terminal
Executing command cd /home/ubuntu/tesla_analysis/data && python3 tesla_technical_analysis.py
shell3
ubuntu@sandbox:~/tesla_analysis/data $ cd /home/ubuntu/tesla_analysis/data && cd /home/ubuntu/tesla_analysis/data && python3 tesla_technical_analysis.py
Bad key font.manager.use_fontconfig in file /home/ubuntu/.config/matplotlib/matplotlibrc, line 33 ('font.manager.use_fontconfig : True')
You probably need to get an updated matplotlibrc file from https://github.com/matplotlib/matplotlib/blob/v3.10.1/lib/matplotlib/mpl-data/matplotlibrc or from the matplotlib source distribution
Performing technical analysis on Tesla stock...
Loaded historical price data with 178 records
Data preparation complete
Calculating moving averages...
Calculating MACD...
Calculating RSI...
Calculating Bollinger Bands...
Identifying support and resistance levels...
Current price: $284.65
Key resistance levels: ['$381.59']
Key support levels: ['$175.79', '$123.10', '$12.52']
Analyzing volume patterns...
Analyzing price trends...
Calculating momentum indicators...
RSI: 59.31 - Neutral
  
```

I'd like a thorough analysis of Tesla stock, including:

- Summary: Company overview, key metrics, performance data and investment recommendations
- Financial Data: Revenue trends, profit margins, balance sheet and cash flow analysis
- Market Sentiment: Analyst ratings, sentiment indicators and news impact
- Technical Analysis: Price trends, technical indicators and support/resistance levels
- Compare Assets: Market share and financial metrics vs. key competitors
- Value Investor: Intrinsic value, growth potential and risk factors
- Investment Thesis: SWOT analysis and recommendations for different investor types

Tesla Stock Analysis Dashboard

Comprehensive analysis of Tesla's financial performance, market position, and investment outlook

Executive Summary

Tesla maintains a dominant position in the EV market with significant technological advantages, strong brand recognition, and expanding manufacturing capacity. While the company has demonstrated impressive revenue growth (42.3% CAGR over 5 years) and achieved consistent profitability, our discounted cash flow analysis suggests the current stock price exceeds our calculated intrinsic values across multiple scenarios.

Investment Recommendations

Growth	Hold/Selective Buy
Value	Avoid
Income	Avoid
Speculative	Selective Buy/Trade
ESG	Buy

Financial Performance

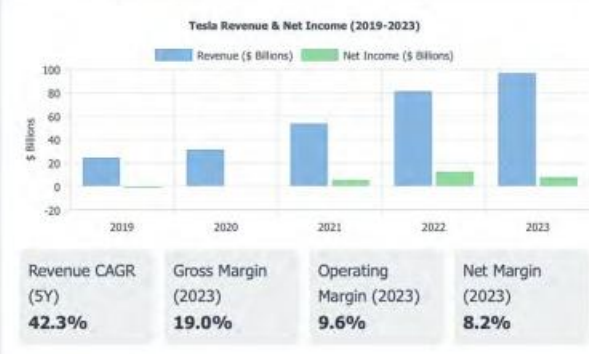

Valuation Analysis



Technical Analysis



Market Position



Personalized Products



Personalized Virtual Assistants



Personalized Landing Pages



Personalized Advice

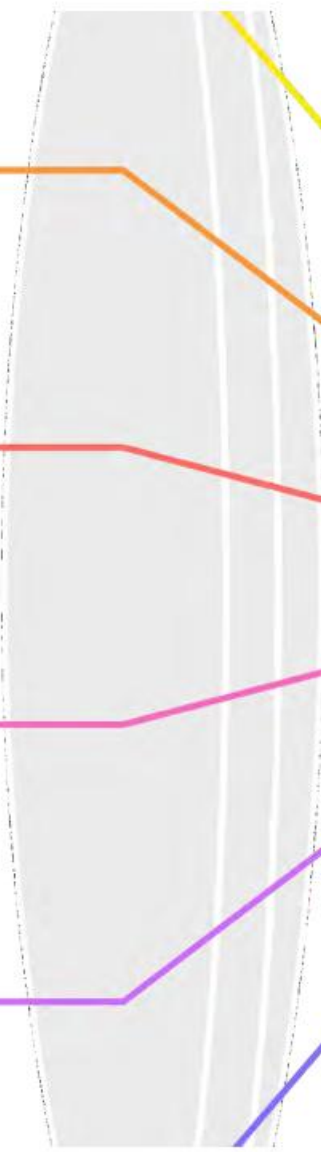

Enhanced Customer Experience



Acceleration – QuSkillbridge.ai

Review a 11-chapter 200-page research report on AI and Big data and create a course with slides, videos and Python-based labs geared towards professionals



Hours to create a Professional Course with Slides, videos, assessments and labs

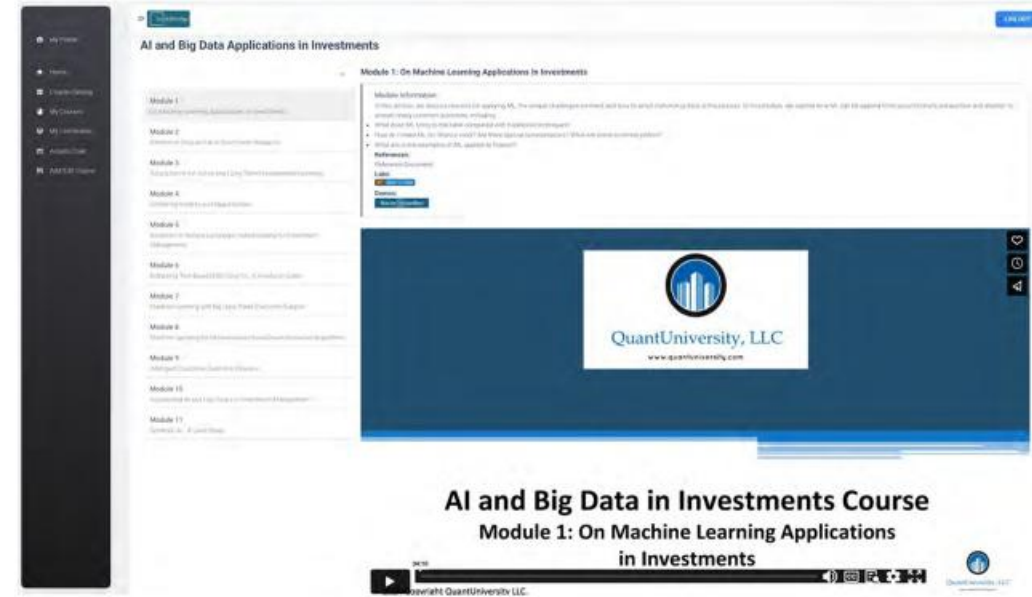

*You can check it out yourselves at www.QuSkillbridge.ai

Validation



Source: <https://weaviate.io/ebooks/agentic-architectures>



Agentic Architectures for retrieval-intensive applications

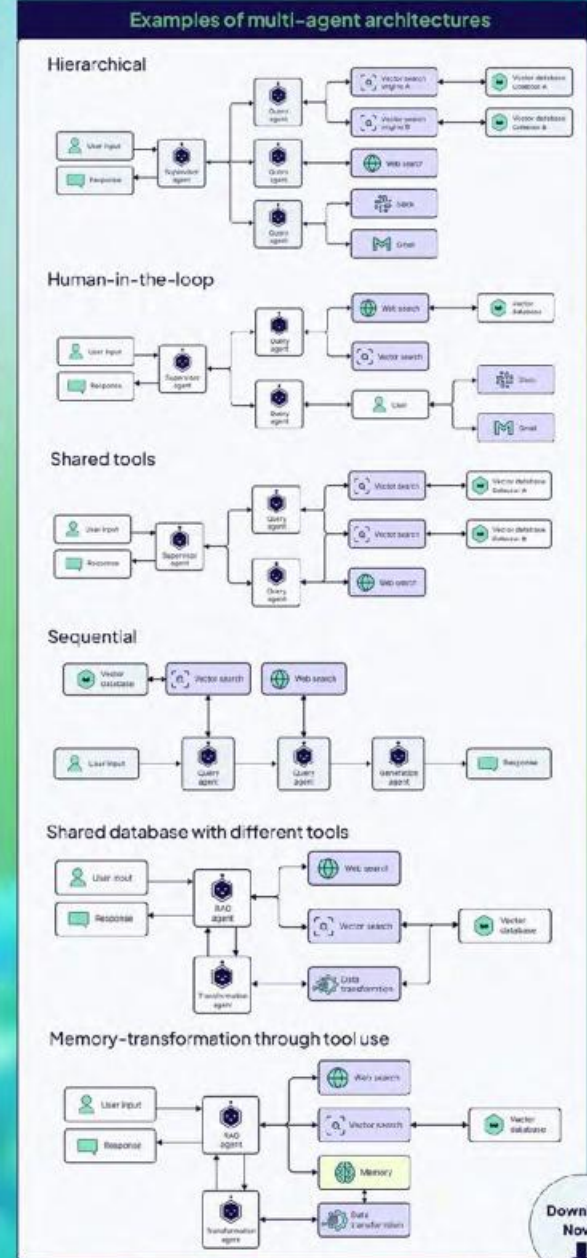
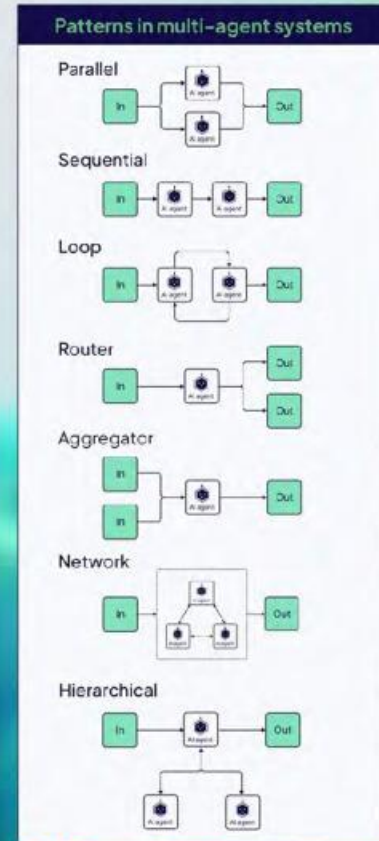
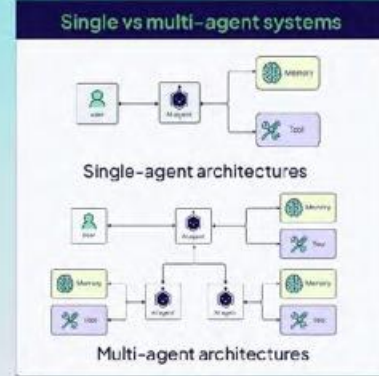

Value – But at what cost?

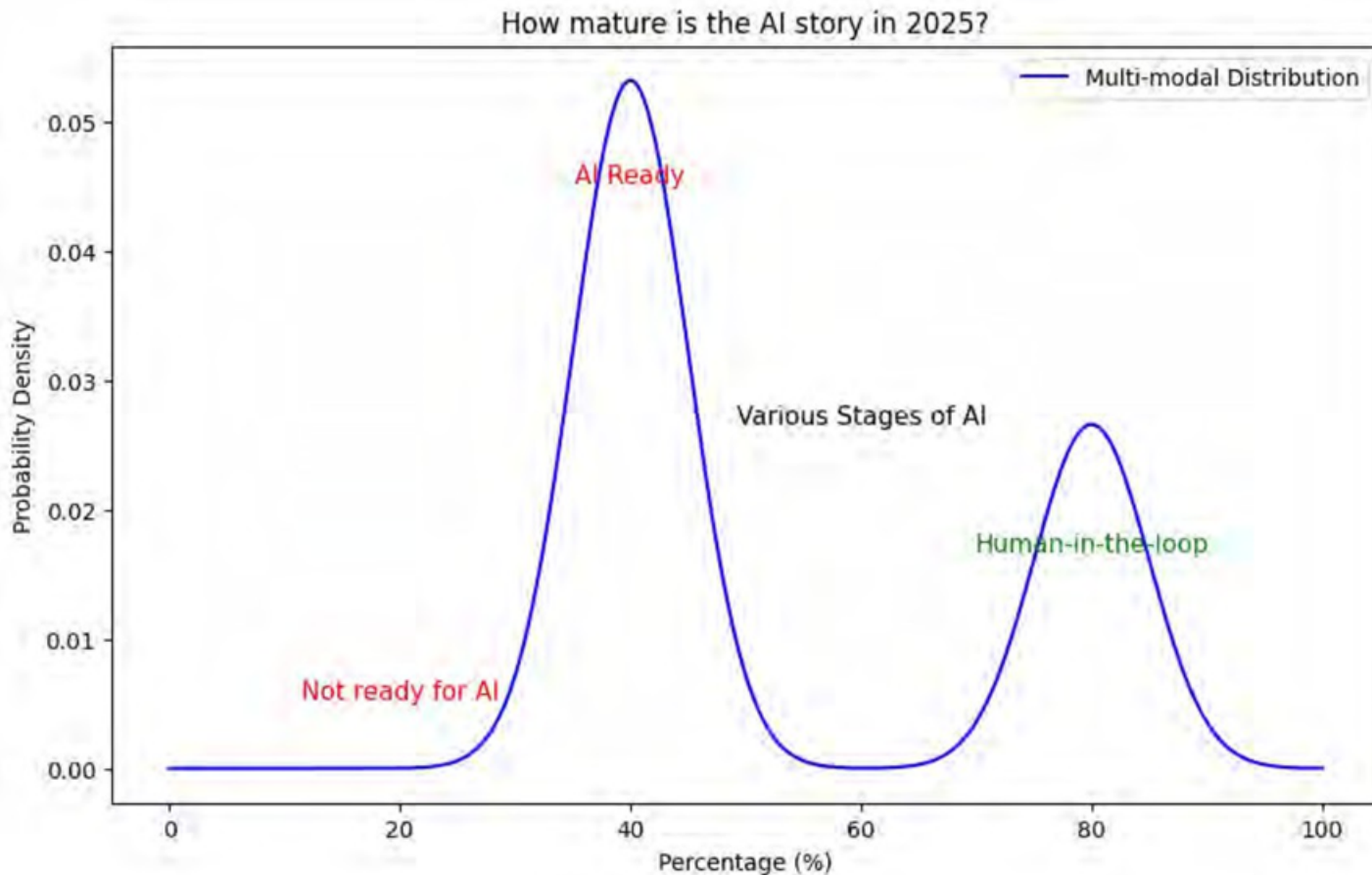

- AI maturity is not uniform; some use cases are advanced, while others lag.
- Organizations need to assess their use cases and strategically deploy AI.
- A significant portion is still "not ready for AI". This could change as AI evolves in the future!

What will you do with AI in 2025?

- Big thanks to the AI applications Napkin.ai, ChatGPT, Excalidraw, Google Colab Agents, MANUS, and DALL-E for making me look cooler and smarter than I really am.
- Without you, I'd have to do all these visualizations myself in Powerpoint and nobody wants to do that anymore in this age of AI!

Sri Krishnamurthy, CFA

www.quantuniversity.com

Contact me at sri@quantuniversity.com





Sri Krishnamurthy, CFA
Founder and CEO
QuantUniversity



- Founder of www.QuantUniversity.com
- Research Advisory and Consultancy focused on adoption of frontier technologies in Financial Services
- Prior Experience at MathWorks, Citigroup and Endeca and 25+ financial services and energy customers
- Columnist for the [Wilmott Magazine](#)
- Author of forthcoming book [“AI & Risk Management \(Wiley\)”](#)
- Chartered Financial Analyst and Certified Analytics Professional
- Teaches AI, Data Science and Fintech related topics at [Northeastern University, Boston](#)



Artificial Intelligence

Exploring the art of the possible



Artificial Intelligence is not new

Artificial intelligence (AI) applies advanced analysis and logic-based techniques, including machine learning, to interpret events, and support and automate decisions and actions*.



Common terms associated

- **Traditional AI** focuses on performing specific tasks using predefined rules and data. For example, a spam filter in your email that identifies and moves spam messages to a separate folder.
- **Generative AI** creates new content based on patterns it has learned. Think of it like an AI that can write a poem or generate an image from a text description, such as DALL-E.
- **Agentic AI** refers to AI systems that can make decisions and take actions autonomously. An example would be a self-driving car that navigates traffic and makes driving decisions on its own.
- **General AI** is the concept of an AI that can understand, learn, and apply knowledge across a wide range of tasks, similar to human intelligence..



With AI, a balanced approach is critical

The Concerns:

AI

The Benefits:

- **Legal** – some models have been trained on copyrighted material that substitute infringement
- **Ethical** – many models are trained on biased datasets
- **Accuracy** – it will frequently produce false information
- **Privacy** – submissions can be publicly accessible
- **Security** – can be used to generate more sophisticated cyber attacks
- **Regulation** – Has not kept pace with capabilities or adoption (but is actively working to catch up)
- **Over-Reliance** – Using output as-is without human oversight or critical thinking

- **Accelerates knowledge work** – can provide summaries, article generation, reports, and more to free up time for more value-added work
- **Enhances creativity** – Provides more thorough explanation of topics based on vast inputs; can synthesize a combination of ideas to generate new ideas; can provide many options of content to pick from and adapt to a specific need
- **Accelerates decisions** – Can analyze vast amounts of data and present insights that are hard for humans to detect; helps knowledge workers make more informed decisions through a more comprehensive understanding of the data
- **Personalization** – Highly nuanced replies based on individual's prompts over time leads to more efficient learning, recommendations, and content generation
- **Automation** – of routine, transactional tasks



We believe that Generative AI:

- Can improve experiences and enhance service
- Will have a significant impact on our society
- Needs to be embraced or else we will be left behind
- Won't replace people but will radically change the way in which we all work

Our direction: Keep humans in the loop

- We will apply Generative AI with caution
- All use cases will involve human-AI teaming. Our people review and discuss outputs and assess the confidence levels
- We focus on learning about the technology to drive meaningful results in the future. We won't deploy Generative AI just for the sake of it
- We follow a Red-Blue Team approach to inform discussions and decisions
 - Red reviews the negative side of the experiments (risks)
 - Blue Team identifies the positive side (all the possibilities)



Our approach:

Nationwide has formed a cross-functional AI Executive Steering Committee comprising leaders across the organization to evaluate implementing AI quickly and safely. This governance structure considers both innovation and protection.

Our belief:

Generative AI helps automate the routine and free up employees to do their best, most human work.



Preparing employees for a GenAI future

1. Access to hands-on learning

- All associates have access to and are encouraged to experiment with Copilot in Edge, a Microsoft Gen AI tool

2. AI Playground

- Nationwide has deployed an AI playground granting access to select people/teams to test a series of use cases with multiple external tools

3. Training and Development

- The roll-out and continued support of our Future Ready Associate Development with a focus on AI Literacy

4. Vendor strength

- We are identifying which vendors are leveraging Gen AI and how we and our partners/participants might benefit from it



Generative AI necessitates that the workforce of the future possess skills such as prompt writing, critical thinking, source validation, analytical judgement, adaptability, emotional intelligence, common sense/experience, technology skills/platforms knowledge, and tech languages



Generative AI Prompt Library

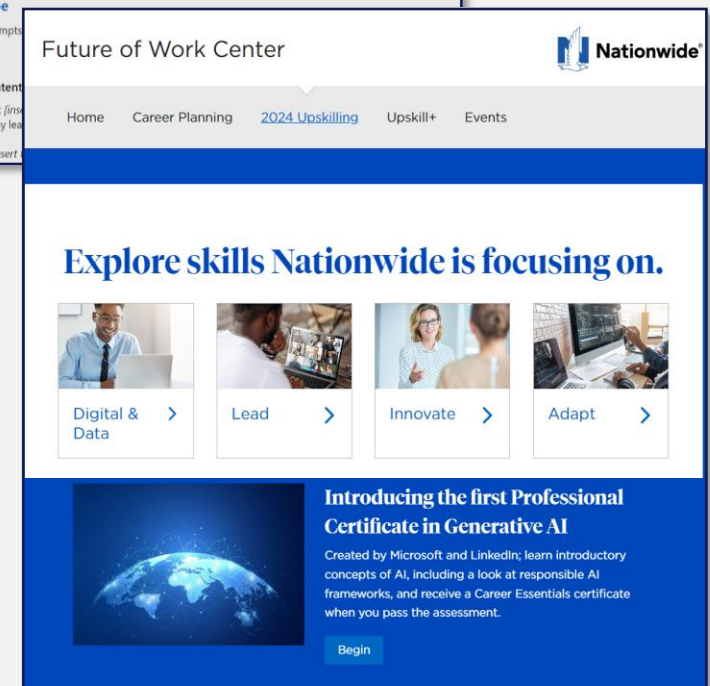
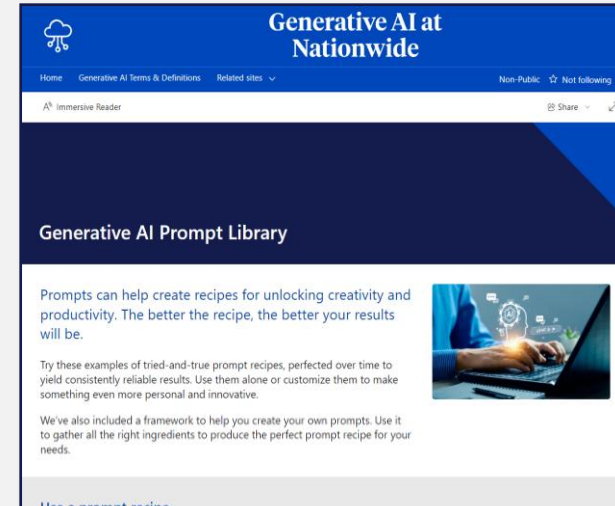

Future of Work Center

Advancing AI in Retirement Update

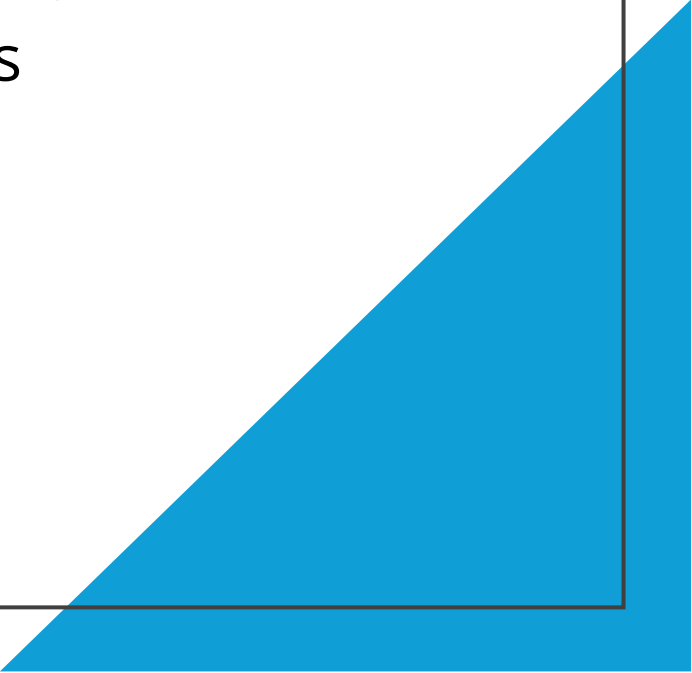
- Sri Krishnamurthy, CEO & Founder, QuantUniversity
 - Randy Blaha, Vice President, Retirement Solutions Technology, Nationwide
 - Moderator: Bridget Bearden, Research and Development Strategist, EBRI
- 

Post Election Retirement Policy Update – What is on the Horizon?

- *Fireside Chat* — Edmund Murphy, President and CEO, Empower, and Stephanie Dhue, News Producer, CNBC

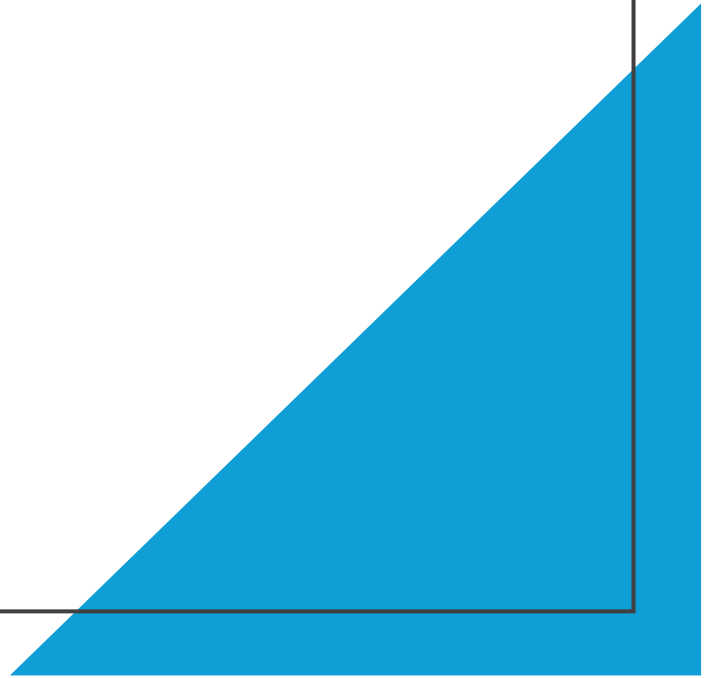

Networking Break

Thank you to our Sponsors!



Expanding Private Retirement Coverage for Small Businesses

- Renee Grimm, Senior Vice President, Retirement Plan Division Manager, Capital Group
- Shelly Horwitz, Managing Director, World Investment Advisors
- *Moderator:* Amy Resnick, Executive Editor, PLANSPONSOR Digital, and Chief Investment Officer, ISS-Stoxx Financial Publications

Working and Saving in 2030 and Beyond

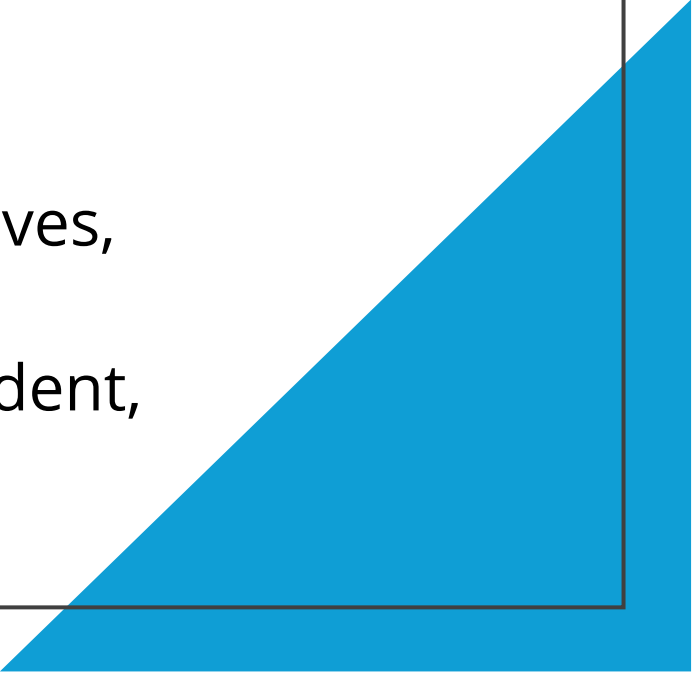
- The Honorable Laura M. Montoya, New Mexico State Treasurer
 - Rob Shapiro, Senior Advisor, Milken Institute
 - Lauren Palumbo, Leader of Future Growth Initiatives, Prudential Financial
 - *Moderator:* Michael Piwowar, Executive Vice President, Milken Institute
- 



Next Generation Act

Senate Bill 397 - Sponsored by Senator Maestas & Senator Jaramillo

Investing in New Mexico's Future with NM Baby Bonds

What are NM Baby Bonds?

New Mexico Baby Bonds will create a government-funded trust account which will incur interest and provide startup capital to every baby born in New Mexico after July 1, 2025. Once they reach adulthood, Baby Bond recipients will have indirect access to the accumulated funds, which will provide them with the opportunity to invest in higher education, or trade school, a down-payment on a home or reliable vehicle, capital to start a business, or retirement savings.

NM Baby Bonds: Our Vision

Every child born in New Mexico after July 1, 2025 will be provided with a trust fund of \$7,000, which will be tied to their name and social security number and invested on their behalf.

Prior to accessing the funds, recipients must complete a financial literacy course approved by the State Treasurer's Office.

After the age of 18, recipients can use the accumulated earnings from their Baby Bonds account towards education, home/car ownership, a business, or retirement.

"One of the biggest obstacles preventing young adults from building wealth is access to capital. We have an incredible amount of talent, ingenuity, and creativity in our state. Investing in our children is an investment into our families, our economy, and our future."



State Treasurer Laura M. Montoya

Laura M. Montoya

Why Baby Bonds?



Access To Wealth

Baby Bonds can break cycles of generational poverty. By providing access to start-up capital tied with financial education, Baby Bonds can provide opportunity and help recipients avoid unmanageable debt.



Bridge the Wealth Divide

Recipients, regardless of their income level or background, can access funds that reduce or eliminate economic disparities and allow for equal opportunities and resources to foster financial independence.



Improve Health Outcomes

Recipients would be less stressed and anxious about finances and have hope for the future, resulting in improved mental and physical wellbeing, greater life expectancy, and increased contribution to community.



Strengthen Our Economy

Baby Bonds creates opportunity, keeps money and people in our state, invests in our workforce, and builds our tax base, which will strengthen our economy and reduce reliance on public assistance.

- ✓ **CHILD WELL-BEING**
New Mexico is ranked **50th**.
Source: The Annie E. Casey Foundation, 2024 Kids Count Data Book
- ✓ **ECONOMIC WELL-BEING**
New Mexico is ranked **48th**.
Source: The Annie E. Casey Foundation, 2024 Kids Count Data Book
- ✓ **EDUCATION**
New Mexico is ranked **50th**.
Source: The Annie E. Casey Foundation, 2024 Kids Count Data Profile
- ✓ **FAMILY AND COMMUNITY**
New Mexico is ranked **49th**.
Source: The Annie E. Casey Foundation, 2024 Kids Count Data Profile
- ✓ **FOOD & HOUSING INSECURITY**
58% of NM college students don't always know where their next meal is coming from and **62%** have had unstable housing.
Source: 2023-2024 NM Higher Education Basic Needs Report
- ✓ **HEALTH**
New Mexico is ranked **44th**.
Source: The Annie E. Casey Foundation, 2024 Kids Count Data Book
- ✓ **HIGHER EDUCATION**
New Mexico colleges and universities have **historically underperformed** the national average graduation rate for both full-time and part-time students... Low retention and graduation rates may result from a variety of factors, including the **cost of education**, academic preparedness, and **other stressors**.
Source: New Mexico Legislative Finance Committee Performance Report Card, Second Quarter, Fiscal Year 2024
- ✓ **HIGH SCHOOL ENROLLMENT**
In twenty states, public school enrollments are projected to fall by more than 10 percent by 2031. Almost all of these states with larger enrollment declines are blue states, with Hawaii, California, **New Mexico**, and New York leading the drops between 19 and 21 percent. ... As school enrollments start to plummet, so will their **funding**.
Source: The Washington Times, December 24, 2024
- ✓ **HIGH SCHOOL GRADUATION RATES**
New Mexico is **among the lowest ranking states** in the nation in high school graduation, with students tending to drop out in ninth and 10th grades.
Source: New Mexico Legislative Finance Committee Progress Report, January 15, 2024

- ✓ **INCARCERATION**
With an incarceration rate of 647 per 100,000 residents, New Mexico locks up a **higher percentage** of its people than any **independent democratic country on earth**.
Source: Prison Policy Initiative, New Mexico Profile
- ✓ **POVERTY**
One measurement, the Official Poverty Measurement, shows New Mexico to be 50th in the nation for child poverty. But the Supplemental Poverty Measurement shows the state as ranking **17th** in the nation.
Source: New Mexico Voices for Children, November 20, 2024

In FY24, New Mexico spent **\$10.8 billion** of state and federal funds on income support programs. In FY24, the state spent \$1.9 billion of general fund dollars. The state's spending on these programs **has more than doubled** in six years.
Source: New Mexico Legislative Finance Committee Progress Report, December 11, 2023
- ✓ **PUBLIC ASSISTANCE**
Total Medicaid and CHIP enrollment in New Mexico was 768,344 in June 2024. Total Medicaid spending in fiscal year 2022 was **\$8.1 billion** in New Mexico.
Source: KFF, Election 2024: State Health Care Snapshots
- ✓ **SUBSTANCE USE**
New Mexico consistently has the **highest alcohol-related death rate** in the country and ranked sixth nationally for drug overdose deaths in 2021.
Source: New Mexico Legislative Finance Committee Progress Report, August 24, 2023
- ✓ **SUICIDE**
In 2022, the most recent data available, New Mexico had the **fourth highest** suicide rate (24.7 per 100,000 residents) in the United States.
Source: NMHealth, September 5, 2024
- ✓ **VIOLENCE**
New Mexico topped a recent Forbes list of 'Most Dangerous States' with the **highest violent crime rate** in the nation.
Source: Forbes, March 2024

✓ We have the **NEED...**
✓ We have the **MONEY...**
✓ The time is now!

SUPPORT SB 397!!

Two Models of Investment



Model 1 - Standard Savings Account Model

Under this model, the State makes an investment at birth for every child born in New Mexico. The annual cost for a \$3,000, \$5,000 or \$7,000 investment is shown below, along with the total cost to the State for twelve cohorts of babies. Over 120,000 babies would claim anywhere from \$950 million (\$3,000 investment, 4% rate of return) to \$4.53 billion (\$7,000 investment, 7% rate of return). The excess fund balance in the account could be used to reduce the annual cost going forward, carry the fund through lean budget times, or be used to pay for an expansion of the policy to other priority populations.

	Annual Appropriation	Appropriation, 12 Years	Payout, through 2060	Excess Fund Balance, 2060
\$3,000 Investment	\$64,800,000	\$752,446,000	\$1,943,504,000	\$2,818,372,000
\$5,000 Investment	\$108,000,000	\$1,254,076,000	\$3,239,174,000	\$4,697,286,000
\$7,000 Investment	\$151,200,000	\$1,755,706,000	\$4,534,844,000	\$6,576,200,000

Two Models of Investment



Model 2 - Large Upfront Investment Model

In this model, the State makes a large upfront investment to seed a savings account fund. Participants claim a minimum guaranteed amount (equivalent to a \$3,000, \$5,000 or \$7,000 investment at birth, plus interest). The total payout for twelve cohorts of babies is the same, but the total cost to the state is slightly less under the \$5,000 and \$7,000 investment scenarios.

	Annual Appropriation	Appropriation, 12 Years	Payout, through 2060	Excess Fund Balance, 2060
\$3,000 Investment	\$0	\$700,000,000	\$1,943,504,000	\$4,350,360,000
\$5,000 Investment	\$0	\$700,000,000	\$3,239,174,000	\$2,268,196,000
\$7,000 Investment	\$0	\$700,000,000	\$4,534,844,000	\$186,031,000

Assumptions



A few assumptions

- We assume a slowly declining birth rate of -0.6 percent
- Static mortality rates & static emigration rates
- Beneficiaries claim at a steady rate from 18-35
- 7 percent annual return on investment
- 100 percent claim rate (this is aggressive but may make sense given the other assumptions)

Conclusion



A \$7,000 investment is worth \$24,000 at age 18, \$38,000 at age 25, and \$75,000 at age 35



Babies born in New Mexico through 2037 would claim over \$4.5 billion through 2060



For this benefit, the cost to the state is between \$700 million (invested upfront) to \$1.8 billion (invested annually at birth)



A New Mexico Baby Bonds Fund would be in the black through 2060



Policy choices and the assumptions will significantly affect model, especially over time

Thank you to our Sponsors!



Thank you all for attending the EBRI-Milken Institute Retirement
Symposium: The Forces Transforming Retirement